



# SAFEWAZE™

## Instruction Manual for Self Retracting Devices

### WARNING



This product is part of a personal fall arrest, work positioning, or rescue system. The manufacturer's instructions must be provided to users of this equipment. The user must follow the manufacturer's instructions for each component of the system. The user must read and understand these instructions before using this equipment. Manufacturer's instructions must be followed for proper use and maintenance of this equipment. Alterations to this product, misuse of this product, or failure to follow instructions may result in serious injury or death.

### IMPORTANT



Questions regarding the use, care, or suitability of this equipment for your application? Contact SAFEWAZE™.

### IMPORTANT



Record identification information before using this product. Identification information may be found on the equipment label (see figure 16) and etched into the equipment casing (see figure 17). This information should be recorded in the "Inspection and Maintenance Log" located at the back of this manual (p 20).

**ANSI Z359.14 and ANSI/ASSE A10.32**

**This manual is intended to meet the manufacturer's instructions as required by ANSI Z359.14 and should be used as part of an employee training program as required by OSHA.**

**TABLE 1  
SAFEWAZE SINGLE LEG WEB RETRACTABLE LIFELINE MODELS**



SINGLE	Length	Material	Carabiner					Housing	Carabiner
			3/4" Aluminum Swivel Indicator	3/4" Steel Snaphook	1.75" Aluminum Snaphook	1.75" Steel Rebar Hook	Tie Back Hook		
FS-EX1006-W	6	WEB			X			POLY	X
FS-EX1006-W-RBH	6	WEB				X		POLY	X
FS-EX2006-W	6	WEB			X			POLY	X
FS-FSP1407-W	7	WEB			X			ALUMIN	X
FS-FSP1407-W-RBH	7	WEB					X	ALUMIN	X
FS-FSP1407-W-TBH	7	WEB					X	ALUMIN	X
FS-FSP1409-W	9	WEB			X			ALUMIN	X
FS-FSP1409-W-RBH	9	WEB					X	ALUMIN	X
FS-FSP1411-W	11	WEB			X			ALUMIN	X
FS-FSP1411-W-RBH	11	WEB					X	ALUMIN	X
FS-FSP1411-W-TBH	11	WEB					X	ALUMIN	X
FS-FSP1420-W	20	WEB			X			POLY	X
FS-FSP1430-W	30	WEB			X			POLY	X
FS-EX1540-W	40	WEB			X			POLY	X
FS-EX1550-W	50	WEB			X			POLY	X

**Carabiner w/dual bracket**



**Behind the Web**



**Behind the Web**



**TABLE 2  
SAFEWAZE DUAL LEG WEB RETRACTABLE LIFELINE MODELS**

DUAL	Length	Material	Carabiner				Housing	Carabiner w/Dual Bracket	Behind the Web
			3/4" Aluminum Snaphook	3/4" Steel Snaphook	1.75" Aluminum Snaphook	1.75" Steel Rebar Hook			
FS-EX10065-W-BWB	6	WEB	X				POLY		X
FS-EX10065-W-RBH-BWB	6	WEB			X		POLY		X
FS-EX20065-W-BWB	6	WEB		X			POLY		X
FS-EX20065-W-RBH-BWB	6	WEB			X		POLY		X
FS-FSP14075-W	7	WEB		X			ALUMIN	X	
FS-FSP14085-W-RBH	7	WEB			X		ALUMIN	X	
FS-FSP14075-W-TBH	7	WEB				X	ALUMIN	X	
FS-FSP15075-W-BWB	7	WEB		X			ALUMIN		X
FS-FSP15085-W-RBH-BWB	7	WEB			X		ALUMIN		X
FS-FSP1409-W-DL	9	WEB		X			ALUMIN	X	
FS-FSP1409-W-DL-RBH	9	WEB			X		ALUMIN	X	
FS-FSP1409-W-DL-BWB	9	WEB		X			ALUMIN		X
FS-FSP1409-W-DL-RBH-BWB	9	WEB			X		ALUMIN		X
FS-FSP14095-W	11	WEB		X			ALUMIN	X	
FS-FSP14095-W-RBH	11	WEB			X		ALUMIN	X	

**TABLE 3  
SAFEWAZE SINGLE LEG CABLE RETRACTABLE LIFELINE MODELS**

SINGLE	Length	Material	3/4" Swivel Indicator		1.75" Aluminum Snaphook		1.75" Steel Snaphook		Energy Absorber (Indicator)		Housing		Carabiner	
			3/4" Aluminum Snaphook	3/4" Steel Snaphook	1.75" Aluminum Rebar Hook	1.75" Steel Rebar Hook	Energy Absorber (Indicator)	Housing	Carabiner					
FS-FSP1211-G	11	CABLE	X				X					POLY	X	
FS-FSP1211-G-RBH	11	CABLE							X			POLY	X	
FS-FSP1215-G	15	CABLE	X				X					POLY	X	
FS-FSP1220-G	20	CABLE	X				X					POLY	X	
FS-FSP1230-G	30	CABLE	X				X					POLY	X	
FS-FSP1240-G	40	CABLE	X				X					POLY	X	
FS-FSP1250-G	50	CABLE	X				X					POLY	X	
FS-FSP1265-G	65	CABLE	X				X					POLY	X	
FS-FSP9020 (LEADING EDGE)	20	CABLE					X			X		POLY	X	
FS-FSP9030 (LEADING EDGE)	30	CABLE					X			X		POLY	X	
FS-FSP9050 (LEADING EDGE)	50	CABLE					X			X		POLY	X	
FS960-50	50	CABLE	X				X					ALUMIN		
FS-EX2530-G-SL	30	CABLE	X				X					POLY	X	
FS-EX2550-G-SL	50	CABLE	X				X					POLY	X	
FS-EX1080-G	80	CABLE										POLY	X	
FS-EX10-100-G	100	CABLE										POLY	X	
SW-8008-10	10	CABLE					X			X		POLY	X	
SW-8008-10-ALU	10	CABLE						X		X		POLY	X	
SW-8008-10-RBH	10	CABLE							X	X		POLY	X	
SW-8008-10-ALU-RBH	10	CABLE						X		X		POLY	X	
SW-8008-11LE (LEADING EDGE)	10	CABLE					X			X		POLY	X	
SW-8008-11LE-ALU (LEADING EDGE)	10	CABLE				X				X		POLY	X	
SW-8008-11LE-RBH (LEADING EDGE)	10	CABLE							X	X		POLY	X	
SW-8008-11LE-RBH-ALU (LEADING EDGE)	10	CABLE						X		X		POLY	X	

**TABLE 4  
SAFEWAZE DUAL LEG CABLE RETRACTABLE LIFELINE MODELS**

DUAL	Length	Material	3/4" Swivel Indicator		1.75" Aluminum Snaphook		1.75" Steel Snaphook		Energy Absorber (Indicator)		Housing		Behind the Web	
			3/4" Aluminum Snaphook	3/4" Steel Snaphook	1.75" Aluminum Rebar Hook	1.75" Steel Rebar Hook	Energy Absorber (Indicator)	Housing	Behind the Web					
SW-8008-10-DL	10	CABLE					X			X		POLY	X	
SW-8008-10-ALU-DL	10	CABLE					X			X		POLY	X	
SW-8008-10-RBH-DL	10	CABLE							X	X		POLY	X	
SW-8008-10-ALU-RBH-DL	10	CABLE						X		X		POLY	X	
SW-8008-11LE-DL (LEADING EDGE)	10	CABLE					X			X		POLY	X	
SW-8008-11LE-ALU-DL (LEADING EDGE)	10	CABLE				X				X		POLY	X	
SW-8008-11LE-RBH-DL (LEADING EDGE)	10	CABLE							X	X		POLY	X	
SW-8008-11LE-RBH-ALU-DL (LEADING EDGE)	10	CABLE						X		X		POLY	X	

## Descriptions

Figure 1 illustrates key components of SAFEWAZE™ Self Retracting Devices (SRD). Web models contain 6 ft (1.83 m), 7 ft (2.13m), 11 ft (3.35 m), 20 ft (6.09 m), 30 ft (9.14 m), 40 ft (12.19 m) 50 ft (15.24 m) of webbing. Cable models contain various lengths, from 11ft (3.35 m) to 100 ft (30.48 m), of galvanized or stainless steel wire rope cable that retracts within the SRD housing.

SAFEWAZE™ Tie Back SRD's contain 7 ft (2.13 m) poly webbing that retracts within the SRD housing. Tie Back SRD's have an additional web section that is 1.5 ft (0.46 m) long and is wrapped around an anchorage and tied back into itself. (See Figure 14)

Cable models are single leg (The SW8008 series is available in a dual configuration), and can be mounted to a suitable anchor point overhead or worn attached to the dorsal back D-ring of the harness.

Web models come in dual, single, and Tie Back options. Dual leg SAFEWAZE™ SRD's can be mounted to a suitable anchor point overhead or worn attached to the dorsal D-Ring of the harness or with a Behind the Web Bracket. The only cable models that are available in a dual configuration are the SW-8008-10 and SW-8008-11LE series of Self Retracting Devices.

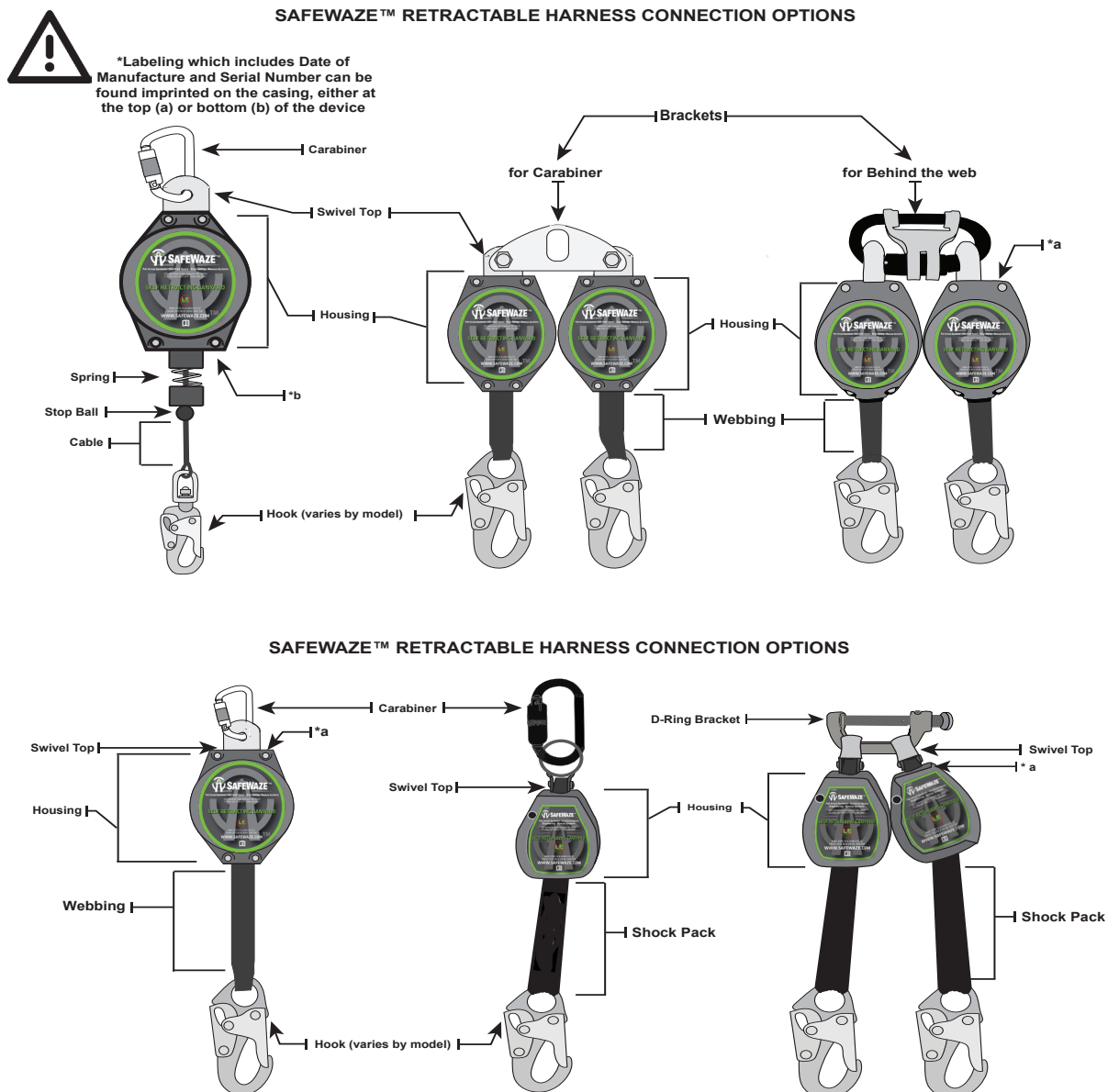
SRD units extend and retract freely with normal movement. If a fall occurs the system locks automatically, arresting the fall, and keeps the worker from falling further.

## 1.0 Applications

### 1.1 Purpose

SAFEWAZE™ SRD's are designed for use in environments where a fall could occur. The purpose is to prevent the fall or limit the potential free fall as much as possible. Applications include, but are not limited to: roofing, concrete, steel, MEP, industrial maintenance, and material handling. Tables 1,2, 3, and 4 show models covered in this manual. Some versions of the SAFEWAZE™ SRD's are designed for 100% tie off and Tie Back options.

**FIGURE 1 - SAFEWAZE™ SELF RETRACTING DEVICE COMPONENTS**



## 1.2 Standards

SAFEWAZE™ SRD's conform to the national standard(s) identified on their ID label. Refer to local, state, and federal (OSHA) requirements for additional information concerning the governing of occupational safety regarding Personal Fall Arrest Systems (PFAS).

**TABLE 5 - ANSI STANDARDS**

ANSI	Z359.0	Definitions and Nomenclature Used for Fall Protection and Fall Arrest
ANSI	Z359.2	Minimum Requirements for a Comprehensive Managed Fall Protection Program
ANSI	Z359.12	Connecting Components for Personal Fall Arrest Systems
ANSI	Z359.14	Safety Requirements for Self-Retracting Devices for Personal Fall Arrest and Rescue Systems
ANSI	A10.32	Personal Fall Protection use in Construction and Demolition

**TABLE 6 - CSA STANDARDS**

CSA	Z259.12-11	Connection Components for Personal Fall Arrest Systems (PFAS)
CSA	Z259.2.2	Self-Retracting Devices for Personal Fall Arrest Systems

## 1.3 Training

This equipment is intended to be used by persons trained in its correct application and use. It is the responsibility of the user to assure they are familiar with these instructions and are trained in the correct care and use of this equipment. Users must be aware of the operating characteristics, application, limits, and the consequences of improper use.

## 2.0 Limitations & Requirements

When installing or using this equipment always refer to the following requirements and limitations:

### 2.1 Capacity

SAFEWAZE™ Retractable Fall Arresters are all designed in compliance with ANSI Z359.14 to meet the weight capacity range of (130-310 lbs). However, there are units that are rated to a higher weight capacity than the ANSI recognized 310 lb maximum. Please see Table 12 and Table 13 on page 21 for higher weight capacity units.

### 2.2 Anchorage

Anchorage selected for fall arrest systems shall have a strength capable of sustaining static loads applied in the directions permitted by the system of at least:

1. 5,000 lbs. (22.2 kN) for non-certified anchorages, or
2. Two times the maximum arresting force for certified anchorages.

When more than one fall arrest system is attached to an anchorage, the strengths set forth in (1) and (2) above shall be multiplied by the number of systems attached to the anchorage.

### From OSHA 1926.500 And 1910.66

Anchorage used for attachment of personal fall arrest systems shall be independent of any anchorage being used to support or suspend platforms, and capable of supporting at least 5,000 lbs (22.2 kN) per user attached, or be designed, installed, and used as part of a complete personal fall arrest systems which maintains a safety factor of at least two, and is under the supervision of a qualified person.



**WARNING:** The anchor point must be located at the same height or above the edge over which a fall might occur. Never anchor SAFEWAZE™ SRD's below user's feet. Workers over 310 lbs (141 kg) must not use these SRD's where falls over edges may occur. Failure to comply with this warning may result in equipment malfunction, serious injury, or death.

## 2.3 INSPECTION FREQUENCY

Either the Authorized Person<sup>1</sup> (User), or the Rescuer<sup>2</sup> must inspect this equipment before each use. Factory authorized inspections must be completed by a Competent Person<sup>3</sup> other than the equipment user. The inspection table (Table 7) located on (p 6) of this manual should be used to determine proper inspection frequency. The inspection checklist (see page 19) describes proper inspection procedures. The Competent Person should record inspection results in the "Maintenance Log" located in the back of this manual. (p20)

- 1 **Authorized Person:** A person assigned by the employer to perform duties at a location where such person will be exposed to a fall hazard.
- 2 **Rescuer:** Person or persons other than the rescue subject acting to perform an assisted rescue by operation of a rescue system.
- 3 **Competent Person:** An individual designated by the employer to be responsible for the immediate supervision, implementation, and monitoring of the employer's managed fall protection program who, through training and knowledge, is capable of identifying, evaluating, and addressing existing and potential fall hazards, and who has the employer's authority to take prompt corrective action with regard to such hazards.

## 2.4 Rescue Plan

When using this equipment, employers must create a rescue plan, and provide the means to implement said rescue plan. This plan must be communicated to equipment users, authorized persons, and rescuers.



**NOTE:** Special rescue measures may be required for a fall over an edge.

**TABLE 7 - INSPECTION SCHEDULE PER ANSI Z359.14**

Type of Use	Application Examples	Conditions of Use	Inspection Frequency Competent Person
Infrequent to Light	Rescue and Confined Space, Factory Maintenance	Good Storage Conditions, Indoor or Infrequent Outdoor Use, Room Temperature, Clean Environments	Annually
Moderate to Heavy	Transportation, Residential Construction, Utilities, Warehouse	Fair Storage Conditions, Indoor and Extended Outdoor Use, All Temperatures, Clean or Dusty Environments	Semi-Annually to Annually
Severe to Continuous	Commercial Construction, Oil and Gas, Mining	Harsh Storage Conditions, Prolonged or Continuous Outdoor Use, All Temperatures, Dirty Environment	Quarterly to Semi-Annually

**2.5 Locking Speed**

The nature of this equipment requires sufficient space in the working area to allow for the SRD to lock. Working in small or confined spaces may keep the user’s body from reaching the speed needed to lock the SRD during a fall. Working on slowly shifting materials, such as grain or sand, may not allow the speed needed to cause the SRD to lock.

**2.6 Normal Operations**

During normal operation the SRD lifeline should freely extend and retract without hesitation. When moving at normal speeds the lifeline will have no slack. A fall will activate the brake system and stop the fall. Avoid sudden or fast movements during normal operation as this may cause the SRD to lock.

**2.7 Free Fall**

In order to ensure reduced fall distances, always attempt to anchor the SRD directly overhead. Overhead anchoring will limit free fall distance to a minimum length. Be aware of workers sharing the workspace to avoid becoming tangled with another worker. Steer clear of objects that could fall and impact the lifeline. The lifeline should never pass under the user’s arms or legs. The lifeline should never be knotted, clamped, or be otherwise restricted from retraction or a taut state.

**2.8 Hazards**

External hazards can require additional precautions to be taken when using this SRD. Hazards may include but are not limited to: Overhead operations, other equipment, other workers, external environment, weather and walking surface. Users should be trained to watch for other hazards not listed here.

**2.9 Sharp Edges**

Use of this equipment should be avoided in areas where the lifeline may come into contact with sharp, abrasive and/or leading edges unless otherwise noted.

**2.10 Body Support**

The SRD must be used with a Full Body Harness. The Full Body Harness must connect via the dorsal D-ring. SAFEWAZE™ SRD’s are not rated for use with a body belt. Use of SAFEWAZE™ SRD’s with a body belt may result in injury.

**2.11 Fall Clearance**

It is important to make sure that adequate clearance is available. To determine this know your free fall, maximum arrest distance, height of worker, and current clearance above the next fall hazard.

**2.12 Determine Fall Clearance Required**

**Determining fall clearance is critical in understanding the correct connecting device to use. The lower the clearance height, the less options available to connect to the anchor point with. To Determine Fall Clearance several factors must be considered:**

**Length of Anchorage connector (LA)**

**Length of Connecting device (LC)**

**Maximum Arrest Distance of connecting device (MAD)**

**Height of Worker (HW)**

**Safety Factor (SF) - (Includes harness stretch, typically 2')**

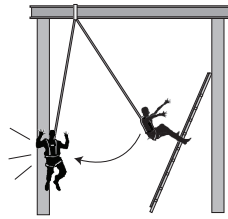
**Distance from Anchor Point to next closest obstruction (DAP)**

Using the above information Fall Clearance (FC) can be determined with the following formula

$$FC \text{ (from anchor point)} = LA + LC + MAD + HW + SF$$

**2.13 Swing Falls** An anchorage point located in a position that is not directly over the user's fall location results in a swing fall (see figure 2). Swing falls may result in the user striking an object with enough force to cause serious injury. Greater clearance is needed to ensure safety during a swing fall as vertical fall distance will be greater than a fall originating directly below the anchorage point.

**FIGURE 2 - SWING FALLS**



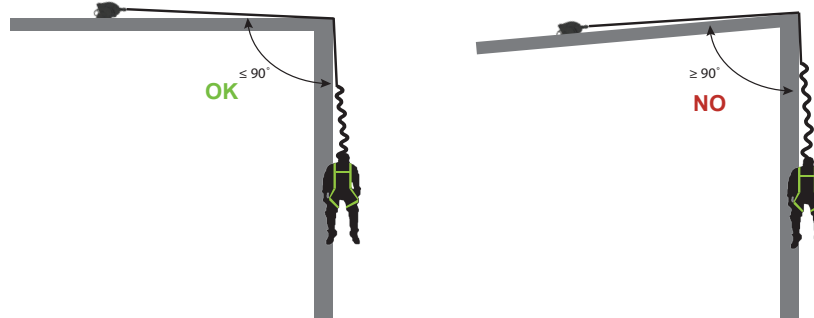
**2.14 Self Retracting Devices with Leading Edge**

Some of the SRD's covered in these instructions include those with Leading Edge capabilities. The five models of SAFEWAZE™ Self Retracting Devices which have Leading Edge capability are the FS9020, FS9030, FS9050, SW-8008-10LE-RBH and SW8008-10LE--RBH-ALU . These units were tested for horizontal use and falls over a steel edge with no burrs.

**Precautions pertaining to Leading Edge SRD's**

1. The angle of redirection allowed regarding the lifeline portion of the LE retractable shall be at least 90 degrees.
2. The anchor point for the LE retractable shall be at the same height or higher than the leading edge over which a fall may occur (see figure 3). An anchor point situated below the level of a leading edge, could cause the lifeline portion of the retractable to exceed a 90 degree angle over the edge in the event of a fall.

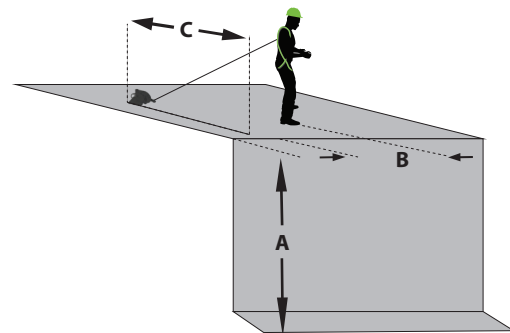
**FIGURE 3 - LE ANCHOR POINT ILLUSTRATION**



3. The user must be aware of all situations which may limit the work area in relation to the anchor point. Factors such as swing fall and abrasion of the lifeline at the Leading Edge should be considered during development of the fall protection plan.
4. User must not work on the far side of an opening opposite his/her anchor point for the LE retractable.

**FIGURE 4 - LE FALL CLEARANCE**

		B					
		0 ft (0.00 m)	2 ft (0.61 m)	5 ft (1.52 m)	10 ft (3.05 m)	15 ft (4.57 m)	20 ft (6.1 m)
C	5 ft (0.61 m)	16.5 ft (5.03 m)	16.9 ft (5.15 m)	18.6 ft (5.67 m)	*****	*****	*****
	10 ft (1.52 m)	16.5 ft (5.03 m)	16.7 ft (5.09 m)	17.7 ft (5.39 m)	20.6 ft (6.28 ft)	*****	*****
	15 ft (4.57 m)	16.5 ft (5.03 m)	16.6 ft (5.06 m)	17.3 ft (5.27 m)	19.5 ft (5.94 m)	22.7 ft (6.92 m)	*****
	20 ft (6.1 m)	16.5 ft (5.03 m)	16.6 ft (5.06 m)	17.1 ft (5.21 m)	18.9 ft (5.76 m)	21.5 ft (6.55 m)	24.8 ft (7.55 m)
	25 ft (7.62 m)	16.5 ft (5.03 m)	16.6 ft (5.06 m)	17 ft (5.18 m)	18.4 ft (5.61 m)	20.7 ft (6.31 m)	23.5 ft (7.16 m)
	30 ft (9.14 m)	16.5 ft (5.03 m)	16.6 ft (5.06 m)	16.9 ft (5.15 m)	18.1 ft (5.52 m)	20 ft (6.10 m)	22.6 ft (6.89 m)
	35 ft (10.67 m)	16.5 ft (5.03 m)	16.6 ft (5.06 m)	16.9 ft (5.15 m)	17.9 ft (5.46 m)	19.2 ft (5.97 m)	21.8 ft (6.64 m)
	40 ft (12.19 m)	16.5 ft (5.03 m)	16.5 ft (5.03 m)	16.8 ft (5.12 m)	17.7 ft (5.40 m)	19.2 ft (5.85 m)	21.2 ft (6.46 m)
	50 ft (15.24 m)	16.5 ft (5.03 m)	16.5 ft (5.03 m)	16.7 ft (5.10 m)	17.5 ft (5.33 m)	18.7 ft (5.70 m)	20.4 ft (6.22 m)



C=Setback Distance, B=Working Distance Along Edge, A=Clearance Required  
 \*\*\*\*\* (Indicates distance along edge is outside safe work radius for setback distance)

## Subdued Edge Capable Units

SAFEWAZE™ currently has two models of SRD's that are capable and rated for falls over a Subdued Edge. The FS-EX2530-G-SL and the FS-EX2550-G-SL have been tested and approved for falls over an edge whose radius meets specific dimensions.

### SUBDUED EDGE CRITERIA

The FS-EX2530-G-SL and the FS-EX2550-G-SL are certified for use in Edge applications where the edge radius is subdued and measures greater than or equal to .02 in (0.5 mm). These units are not to be used for sharp edges, but rather are designed for use over edges that are less pronounced than a leading edge as specified by ANSI Z359.14. The ability of these units to be utilized in regards to specific edges, allows the user to utilize one SRD for multiple work scenarios, or as jobsite conditions change.

With the enhanced capability of the FS-EX2530-G-SL and the FS-EX2550-G-SL, fall clearances in specific Edge work environments can be dramatically reduced since no additional energy absorber is required. This allows Competent and Qualified persons on a jobsite to calculate fall clearances without adding an additional 48 inches to compensate for possible full energy absorber deployment in the event of a fall.

These devices have a range of both mechanical and performance modifications to enable them to meet the requirements of usage in a subdued edge scenario. These include, but are not limited to, upgraded high tensile steel cable, cable reserve system, side-load rated carabiners and enhanced braking systems.

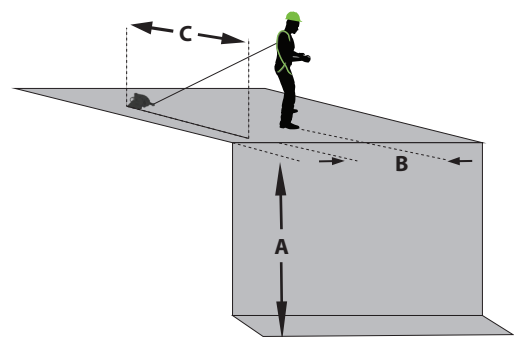
These Subdued Edge rated devices are tested for safe use with a maximum user weight of 300lbs (136kg) when mounted above the user, and 220lbs (100kg) when the device is anchored between head height and foot level of the worker.

All Fall Protection applications should have the appropriate Fall Protection Plan that includes a detailed rescue plan, and all work equipment / processes. All work should only be carried out by suitably trained personnel. Consideration must be given to any edges, ground clearance requirements, clear fall distances and any obstructions.

Working near any edge introduces additional risks and hazards to the user which should always be avoided where possible. Careful selection and configuration of Fall Protection systems (including equipment and anchorage positioning) is essential to prevent a fall over a leading edge. Only if this is unavoidable should Edge or LE equipment be used. Working in a Edge environment requires far more advanced rescue techniques and equipment which must be planned for.

**FIGURE 5 - SUBDUED EDGE FALL CLEARANCE**

		B					
		0 ft (0.00 m)	2 ft (0.61 m)	5 ft (1.52 m)	10 ft (3.05 m)	15 ft (4.57 m)	20 ft (6.1 m)
C	5 ft (1.52 m)	12.5 ft (3.81 m)	12.9 ft (3.93 m)	14.6 ft (4.45 m)	*****	*****	*****
	10 ft (3.05 m)	12.5 ft (3.81 m)	12.7 ft (3.87 m)	13.7 ft (4.18 m)	16.6 ft (5.05 m)	*****	*****
	15 ft (4.57 m)	12.5 ft (3.81 m)	12.6 ft (3.84 m)	13.3 ft (4.05 m)	15.5 ft (4.72 m)	18.7 ft (5.69 m)	*****
	20 ft (6.1 m)	12.5 ft (3.81 m)	12.6 ft (3.84 m)	13.1 ft (3.99 m)	14.9 ft (4.54 m)	17.5 ft (5.33 m)	20.8 ft (6.33 m)
	25 ft (7.62 m)	12.5 ft (3.81 m)	12.6 ft (3.84 m)	13 ft (3.96 m)	14.4 ft (4.38 m)	16.7 ft (5.09 m)	19.5 ft (5.94 m)
	30 ft (9.14 m)	12.5 ft (3.81 m)	12.6 ft (3.84 m)	12.9 ft (3.93 m)	14.1 ft (4.29 m)	16 ft (4.87 m)	18.6 ft (5.66 m)
	35 ft (10.67 m)	12.5 ft (3.81 m)	12.6 ft (3.84 m)	12.9 ft (3.93 m)	13.9 ft (4.23 m)	15.6 ft (4.75 m)	17.8 ft (5.42 m)
	40 ft (12.19 m)	12.5 ft (3.81 m)	12.5 ft (3.81 m)	12.8 ft (3.90 m)	13.7 ft (4.17 m)	15.2 ft (4.63 m)	17.2 ft (5.24 m)
	50 ft (15.24 m)	12.5 ft (3.81 m)	12.5 ft (3.81 m)	12.7 ft (3.87 m)	13.5 ft (4.11 m)	14.7 ft (4.48 m)	16.4 ft (4.99 m)
			A				



C=Setback Distance, B=Working Distance Along Edge, A=Clearance Required

\*\*\*\*\* (Indicates distance along edge is outside safe work radius for setback distance)

Note: Calculations based upon worker being 6' in height, 300 lbs (with SRD mounted above the worker), and 220 lbs (with SRD mounted between head height and foot level)

## 2.15 COMPATIBILITY OF COMPONENTS

Unless otherwise noted, SAFEWAZE™ equipment is designed for use with SAFEWAZE™ approved components and subsystems only. Substitutions or replacements made with non approved components or subsystems may jeopardize compatibility of equipment and may affect safety and reliability of the complete system. **SAFEWAZE™ SAFELINK SRD's are designed specifically for use with the SAFELINK Horizontal Lifeline System.**



**IMPORTANT:** Read and follow manufacturer's instructions for associated components and subsystems in your personal fall arrest system.



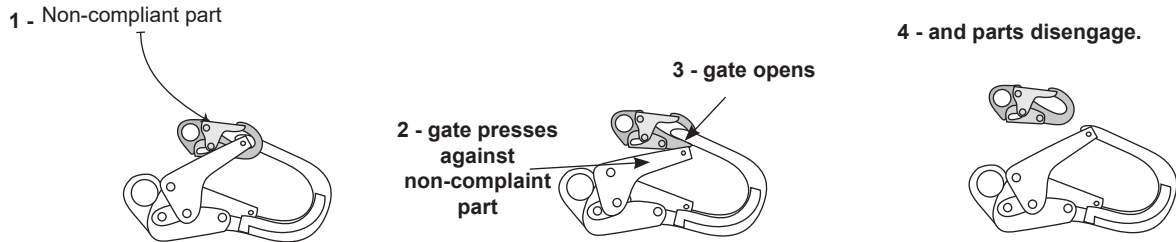
## 2.16 COMPATIBILITY OF CONNECTORS

Connectors are compatible with connecting elements when they have been designed to work together in such a way that their sizes and shapes do not cause their gate mechanisms to inadvertently open regardless of how they become oriented. Connectors (hooks, carabiners, and D-rings) must be capable of supporting at least 5,000 lbs. (22.2 kN). Connectors must be compatible with the anchorage or other system components (see Figure 7). Do not use equipment that is not compatible. Non-compatible connectors may unintentionally disengage (see Figure 6). Connectors must be compatible in size, shape, and strength. Self-locking snap hooks and carabiners are required by ANSI Z359 and OSHA guidelines. Contact SAFEWAZE™ if you have any questions about compatibility.



**NOTE:** SOME SPECIALTY CONNECTORS HAVE ADDITIONAL REQUIREMENTS. CONTACT SAFEWAZE™ WITH QUESTIONS.

**FIGURE 6 - UNINTENTIONAL DISENGAGEMENT**



Using a connector that is undersized or irregular in shape (1) to connect a snap hook or carabiner could allow the connector to force open the gate of the snap hook or carabiner. When force is applied, the gate of the hook or carabiner presses against the non-compliant part (2) and forces open the gate (3). This allows the snap hook or carabiner to disengage (4) from the connection point.

## 2.17 MAKING CONNECTIONS

Snap hooks and carabiners used with this equipment must be double locking and/or twist lock. Carabiners supplied for use with SAFEWAZE™ SRD models FS-EX1006-W and FS-EX1006-W-RBH are triple locking. Ensure all connections are compatible in size, shape and strength. Do not use equipment that is not compatible. Ensure all connectors are fully closed and locked.

SAFEWAZE™ connectors (snap hooks and carabiners) are designed to be used only as specified in each product's user's instructions. (See Figure 7) for examples of inappropriate connections. Do not connect snap hooks and carabiners:

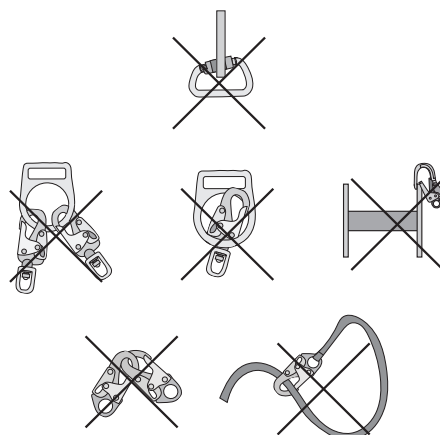
- To a D-ring to which another connector is attached.
- In a manner that would result in a load on the gate (with the exception of tie back hooks). **NOTE:** Large snap hooks must not be connected to objects which will result in a load on the gate if the hook twists or rotates, unless the snap hook complies with ANSI Z359.12 and is equipped with a 3,600 lb (16 kN) gate. Check the marking on your snap hook to verify its compatibility.



**NOTE:** Large throat snap hooks must not be connected to standard size D-rings or similar objects which will result in a load on the gate if the hook or D-ring twists or rotates, unless the snap hook complies with ANSI Z359.12 and is equipped with a 3,600 lb (16 kN) gate. Check the marking on your snap hook to verify that it is appropriate for your application.

- In a false engagement, where features that protrude from the snap hook or carabiner catch on the anchor, and without visual confirmation seems to be fully engaged to the anchor point.
- To each other.
- By wrapping the web lifeline around an anchor and securing to lifeline except as allowed for Tie Back models (see section 4.5).
- To any object which is shaped or sized in a way that the snap hook or carabiner will not close and lock, or that roll-out could occur.
- In a manner that does not allow the connector to align properly while under load.

**FIGURE 7 - INAPPROPRIATE CONNECTIONS**



### 3.0 INSTALLATION

#### 3.1 PLANNING

Plan your fall protection system before starting your work. Account for all factors that may affect your safety before, during, and after a fall. Consider all requirements and limitations defined in section 2.

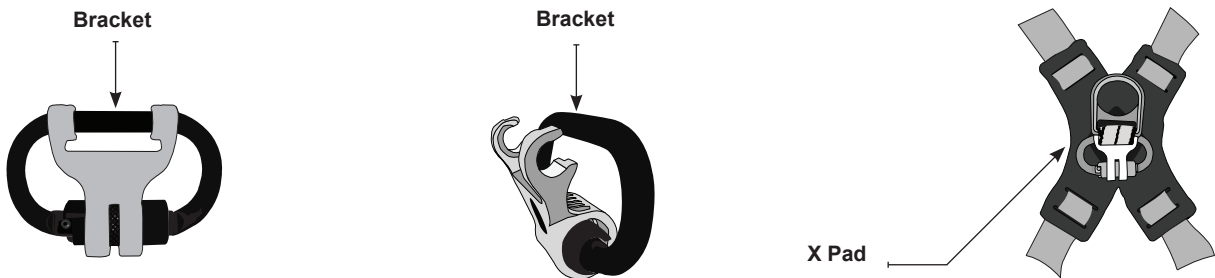
#### 3.2 HARNESS MOUNTING WITH BEHIND THE WEB BRACKET

The behind the web bracket comes fully assembled and ready for installation. No tools are required for installation of the bracket onto harness. Use the following instructions and Figure 8 to install the bracket:

To Fasten To Harness:

1. Unfasten the two small brackets on the green retractable spacer off of the carabiner.
2. Slide the green spacer around to the side of carabiner to allow opening of the carabiner gate.
3. Open the carabiner gate and slide spacer off of carabiner and remove one of the retractables.
4. Holding gate open on carabiner, insert the open end of carabiner through the webbing loops at Dorsal D-ring on the X Pad of harness. Ensure that both loops of webbing on X Pad are inside of carabiner.
5. With carabiner gate still open, slide the removed retractable and green spacer back onto carabiner and allow carabiner gate to close.
6. Slide the green retractable spacer back over the gate of carabiner and snap the two small brackets back into place on carabiner, with the web loops positioned between these two small brackets.

**FIGURE 8 - BEHIND THE WEB BRACKET INSTALLATION**



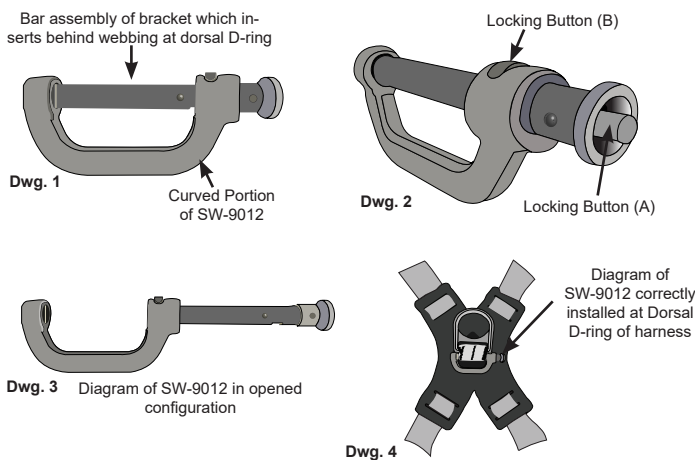
#### 3.3 HARNESS MOUNTING WITH SW-9012 BEHIND THE WEB BRACKET

The D-RING brackets comes fully assembled and ready for installation. No tools are required for installation of the bracket onto harness. Use the following instructions and Figure 9 to install the SW-9012 Behind the Web Bracket. Figure 10 illustrates the Carabiner w/Dual Bracket which simply utilizes a double locking carabiner to attach the bracket to the Dorsal D-Ring of the harness:

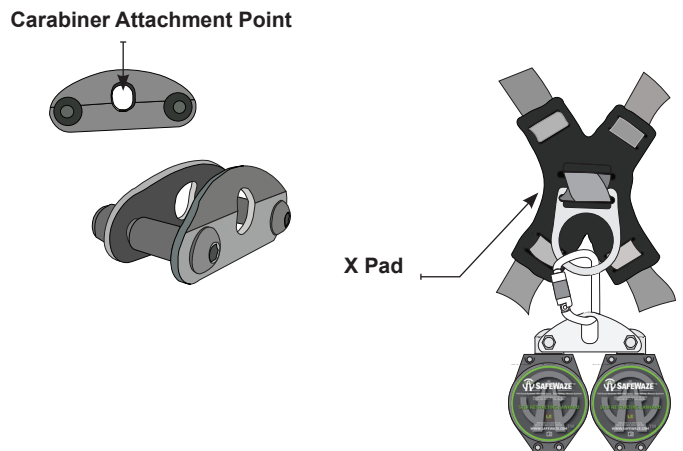
To Fasten To Harness:

1. Ensure that the curved portion of SW-9012 is in a downward orientation relative to the harness (See drawing 1, Figure 9).
2. Simultaneously depress both locking buttons (A) and (B) (See Drawing 2, Figure 9) and slide the bracket open as indicated (See drawing 3, Figure 9).
3. With the bracket open, install dual leg retractables onto the bracket via the swivel tops of each. Swivels should be hanging on the curved portion of bracket.
4. While pressing in on locking button (A) slide the bar behind both loops of webbing at dorsal D-ring until the bar locks back into place.
5. Check the locking function of the bracket by attempting to slide the bracket open WITHOUT depressing locking buttons (A) or (B). Bracket bar should not move and the bracket is now locked into place.

**FIGURE 9 - SW-9012 DUAL BRACKET INSTALLATION**



**FIGURE 10 - CARABINER W/DUAL BRACKET INSTALLATION**



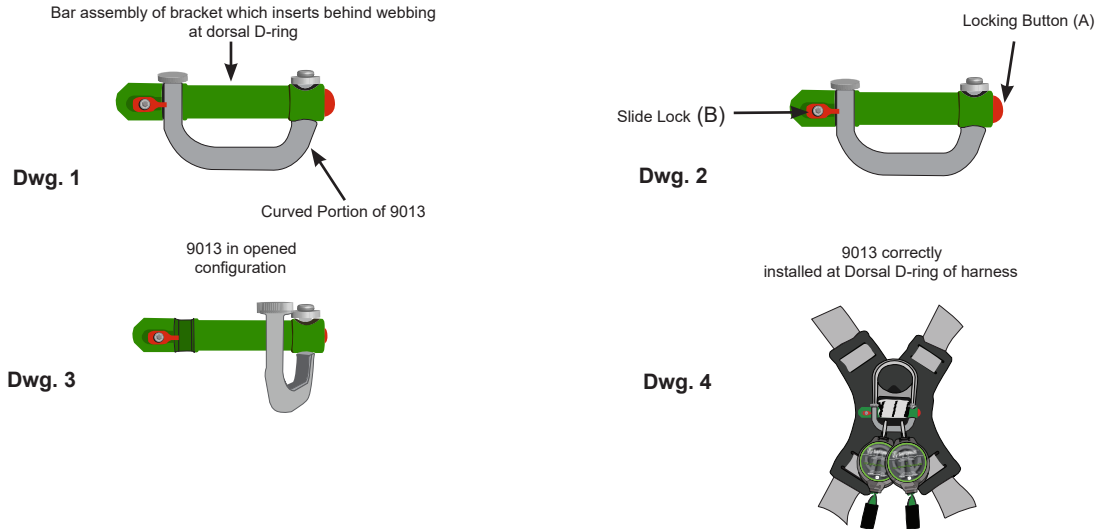
#### 3.4 HARNESS MOUNTING WITH 9013 BEHIND THE WEB BRACKET

The D-RING brackets comes fully assembled and ready for installation. No tools are required for installation of the bracket onto harness. Use the following instructions and Figure 11 to install the 9013 Behind the Web Bracket.

To Fasten To Harness:

1. Ensure that the curved portion of 9013 is in a downward orientation relative to the harness (See Dwg. 1).
2. Simultaneously depress both locking button (A) and and slide lock (B) (See Dwg. 2) to swing the bracket open as indicated (See Dwg. 3).
3. With the bracket open, install dual leg retractables onto the bracket via the swivel tops of each. Swivels should be hanging on the curved portion of bracket.
4. Slide the bar behind both loops of webbing at dorsal D-ring. Swing the bracket closed until it locks into place.
5. Check the locking function of the bracket by attempting to wing the bracket open WITHOUT depressing locking button (A) or slide lock (B). Bracket bar should not move and the bracket is now locked into place.
6. Dual leg Retractable can be easily installed and removed from bracket by once again depressing both locking button (A) and slide lock (B), which allows bracket to swing open without complete removal from harness.

**FIGURE 11 - 9013 DUAL BRACKET INSTALLATION**



### 3.5 HARNESS MOUNTING THE SW-8008-11LE SERIES TO A SAFEWAZE

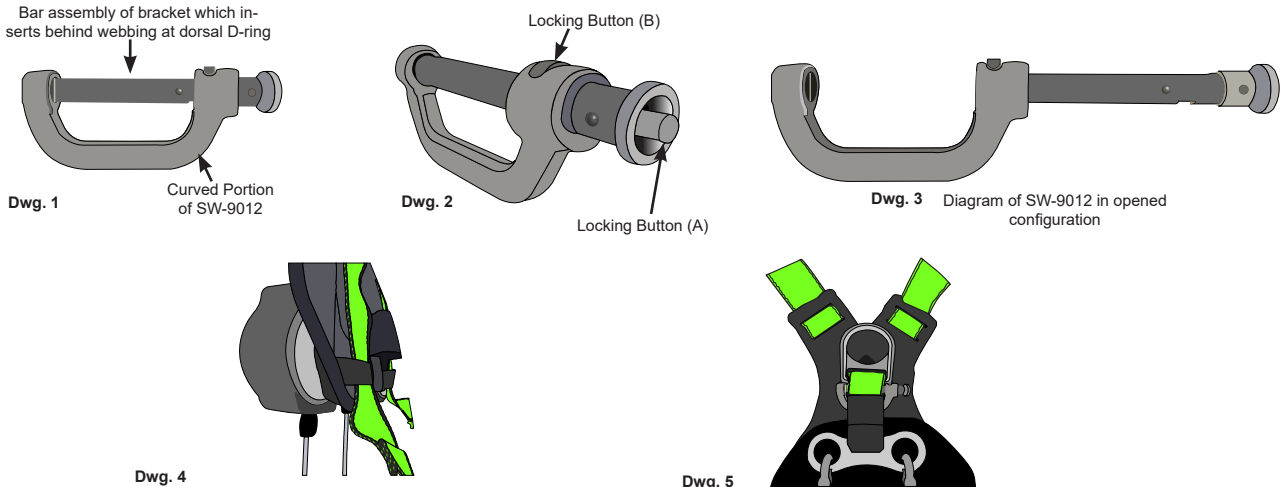
### FULL BODY HARNESS

The bracket comes fully assembled and ready for installation. No tools are required for installation of the bracket onto harness. Use the following instructions and Figure 12 to install the SW-8008-11LE series retractables onto a Safewaze Full Body Harness.

**FIGURE 12 - MOUNTING THE SW-8008-11LE-RBH-ALU TO A SAFEWAZE FULL BODY HARNESS**

To Fasten To Harness:

1. Ensure that the curved portion of SW-9012 is in a downward orientation relative to the harness (See Dwg. 1).
2. Simultaneously depress both locking buttons (A) and (B) (See Dwg. 2) and slide the bracket open as indicated (See Dwg. 3).
3. With the bracket open, install web loop of the SW-8008-10LE-RBH-ALU backpack assembly onto the bracket. The web loop should be hanging on the curved portion of bracket.
4. While pressing in on locking button (A) slide the bar behind both loops of webbing at dorsal D-ring until the bar locks back into place.
5. Check the locking function of the bracket by attempting to slide the bracket open WITHOUT depressing locking buttons (A) or (B). Bracket bar should not move and the bracket is now locked into place.
6. Fasten the underside of the backpack assembly to the Full Body Harness Shoulder straps via the hook and loop fastener tabs as indicated (See Dwg. 4).
7. Installation of unit to Dorsal D-ring webbing should appear as indicated (See Dwg. 5)



## 4.0 USE



**WARNING:** Contact SAFEWAZE™ if you have questions, regarding compatibility of this equipment, that are not covered in this manual. Do not alter or misuse this equipment. Some subsystem components could affect the performance of the operation of this equipment. Do not anchor this product to moving machinery, hazards that include chemical, electrical or gaseous characteristics. Failure to comply with this warning could result in injury or death.



**WARNING:** Consult your doctor if there is reason to doubt your fitness to safely absorb the shock from a fall arrest. Age and fitness seriously affect a worker's ability to withstand falls. Pregnant women or minors must not use SAFEWAZE™ SRD's. Failure to heed this warning may result in serious injury or death.

## 4.1 OPERATION

Inspect the SRD, as described in section 8, before using the equipment. Refer to figure 15 for the most common system connections used with SRD applications. Depending on the SRD model, mount the SRD either to an approved anchor point or on the back of a Full Body Harness as described in section 3.2. Connect the snap hook, carabiner or tie back attachment to a suitable anchorage. Ensure connections are compatible in size, shape, and strength. Ensure hooks are fully closed and locked. When the worker is fully attached, the worker is then free to move about within the recommended working area. If a fall occurs, the SRD will lock and arrest the fall. Upon rescue, remove the SRD from use. When working with an SRD, always allow the lifeline to retract back into the device in a controlled manner. Do not release the unit to "free-spin" back into itself.



**WARNING:** Do not tie or knot the lifeline. Avoid lifeline contact with sharp or abrasive surfaces. Inspect the lifeline frequently for cuts, fraying, burns, or signs of chemical damage. Dirt, contaminants, and water can lower performance of the lifeline. Use caution near power lines. Failure to comply with this warning may result in serious injury or death.

## 4.2 AFTER A FALL

Equipment exposed to the force of a fall, or that shows damage consistent with the effects of a fall, must be removed from service immediately. Equipment must then be repaired (see section 5.1) in the correct manner or disposed of (see section 8.5).

## 4.3 BODY SUPPORT

A full body harness must be worn when using SAFEWAZE™ SRD's.



**IMPORTANT:** Do not use a body belt for free fall applications. See OSHA 1926.502 for guidelines.

## 4.4 SYSTEM CONNECTIONS

Figure 15 illustrates harness and anchorage connections for SAFEWAZE™ SRD Fall Arrest Systems. When using a snap hook to make a connection, ensure roll-out cannot occur (see figure 6). Do not use snap hooks or carabiners that will not completely close over the anchor point. This includes traditional overhead anchor point tie off, housing attachment to dorsal D-ring, and 100% tie off. Follow the manufacturer's instructions supplied with each system component.



**WARNING:** Never connect the snap hook of one SRD to the lifeline of another SRD or lanyard. Failure to comply with this warning may result in equipment malfunction, serious injury or death.

## 4.5 TIE BACK OPTIONS

Tie Back Snap Hooks operate in the same manner as standard double locking snap hooks. The gate is rated at 5,000lbs, allowing the unit to be tied back into the webbing extension of the SRD. Grip the hook in one hand. Use the thumb and index finger to squeeze the locking mechanism and gate latch, to open the gate as shown in figure 13. Lessen finger pressure and the gate will close.

To attach to an anchor point, wrap the Tie Back portion of the lifeline around an approved anchor, then open the gate of the Tie Back snap hook and pass the web portion of the lifeline through the snap hook. Ensure that the lifeline only passes through the hook once. Ensure that the Tie Back portion of the lifeline is captured and the gate closes completely. (See Figure 14)

FIGURE 13 - HOOK OPERATION

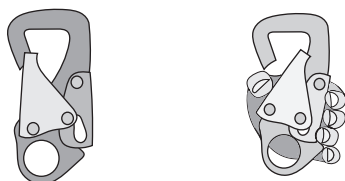
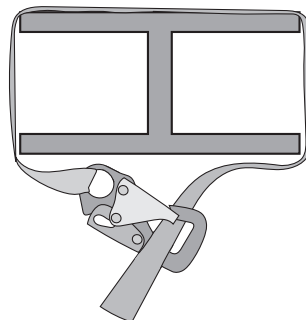


FIGURE 14 - TIE BACK ANCHORING

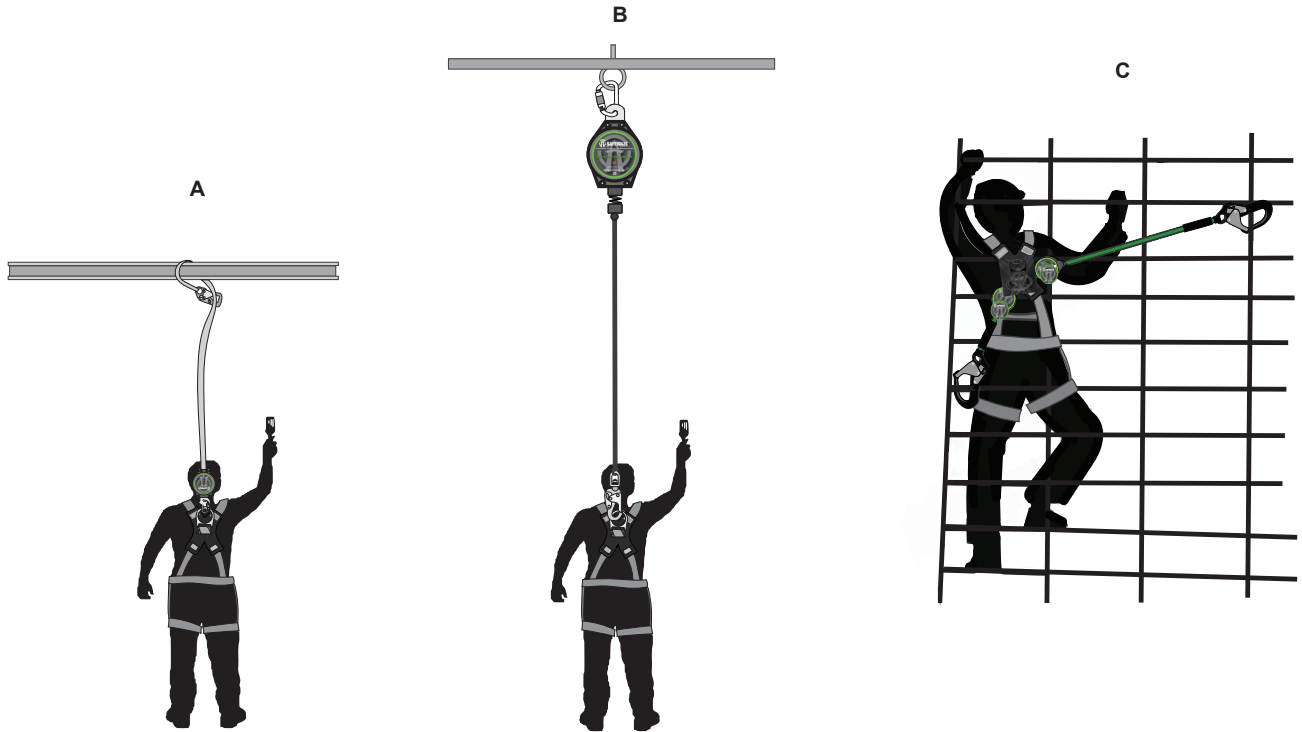


**WARNING:** Only the Tie Back hook may be used to snap back onto the Tie Back portion of the SRD Lifeline. When installed, the Tie Back hook must contact the heavy web section. If the anchor structure is so large that the Tie Back hook contacts the lifeline above the Tie Back portion of the lifeline, a different anchor structure must be used.

## 4.6 ANCHORAGE

Figure 15 illustrates typical SAFEWAZE™ SRD anchorages and connections. Select an anchorage location with minimal free fall and swing fall hazards (see Section 2). Select a rigid anchorage point capable of sustaining static loads as defined in section 2.2. Where anchoring overhead is not feasible, SAFEWAZE™ SRD's may be secured to anchorage points below the level of the user's dorsal D-Ring, but never below the user's feet. NOTE: THIS ADJUSTMENT WILL ADJUST THE TOTAL FREE FALL AND MAXIMUM ARREST DISTANCE OF A FALL.

FIGURE 15 - SYSTEM CONNECTIONS



## 4.7 TWIN LEG SAFEWAZE™ SRD

With the twin leg SAFEWAZE™ SRD mounted on the back of a Full Body Harness, the user can have continuous fall protection (100 % tie-off) while ascending, descending, or moving laterally (see figure 15-C). With the lifeline leg of one SRD attached to an anchorage point, the worker can move to a new location, attach the unused lifeline leg of the other SRD to another anchorage point, and then disconnect from the original anchorage point.



**IMPORTANT:** Never connect more than one person at a time to the twin-leg system.



**IMPORTANT:** Do not allow the lifelines to pass under arms or between legs.

## 5.0 MAINTENANCE, SERVICING, AND STORAGE

### 5.1 SERVICE

Remove the SRD from use if the SRD has been subjected to fall arrest forces or inspection reveals an unsafe or defective condition. If unreparable dispose of the SRD as recommended in section 8.5 or send the unit back to an authorized SAFEWAZE™ Service Center for repair.

### 5.2 CLEANING

Cleaning procedures for SAFEWAZE™ SRD's are as follows:

Periodically clean the exterior of the SRD using water and a mild soap solution. Clean labels to maintain readability.

An excessive buildup of debris on the cable/web may prevent the cable lifeline from fully retracting back into the housing and create a potential free fall hazard.

Clean webbing using water and a mild soap solution. Allow to dry fully before using or allowing web to fully retract into housing.

Clean cable using an acid-free oil or petroleum jelly at regular intervals. Always wear gloves when servicing/inspecting steel cable SRD's.



**IMPORTANT:** If the lifeline comes in contact with acids or other caustic chemicals, remove the SRD from service and wash with water and a mild soap solution. Inspect the SRD (using the Inspection Checklist on p 19) before returning to service.

### 5.3 STORAGE

Store SAFEWAZE™ SRD's in a cool, dry, clean environment out of direct sunlight. Avoid areas where chemical vapors may exist. Thoroughly inspect the SRD after any period of extended storage.

## 6.0 SPECIFICATIONS

### 6.1 PERFORMANCE

SAFEWAZE™ SRD's have been tested and certified to the performance requirements of the standard(s) identified on their ID labels. See Tables 8 & 9 for performance specifications.

### 6.2 MAXIMUM ARREST FORCE AND MAXIMUM ARREST DISTANCE

SRD's documented in this instruction meet the following Arrest Force and Arrest Distance maximums when tested in accordance with Section 4.2.1 of ANSI Z359.14.

**TABLE 8 - CLASS A**

<b>Average Arresting Force</b>	<b>≤ 1,350 lbs (6.0kN)</b>
<b>Maximum Arresting Force</b>	<b>≤ 1,800 lbs (8.0 kN)</b>
<b>Maximum Arrest Distance</b>	<b>24 in (0.61 m)</b>

**TABLE 9 - CLASS B**

<b>Average Arresting Force</b>	<b>≤ 900 lbs (5.0kN)</b>
<b>Maximum Arresting Force</b>	<b>≤ 1,800 lbs (8.0 kN)</b>
<b>Maximum Arrest Distance</b>	<b>54 in (1.37 m)</b>

## 7.0 MATERIALS

**TABLE 10 - MATERIALS**

<b>Housing</b>	Aluminum, Poly, or Thermoplastic	<b>Web</b>	Ultra High Molecular Weight Webbing
<b>Drum</b>	Aluminum Alloy	<b>Dual D-Ring Bracket</b>	Stainless Steel
<b>Fasteners</b>	Zinc Plated Alloy Steel Screws	<b>Motor Spring</b>	Stainless Steel
	Stainless Steel Rivets	<b>Swivel</b>	Zinc Plated Steel
<b>Locking Pawls</b>	Brass	<b>Cable</b>	3/16" Galvanized or Stainless Steel / 7/32" Galvanized Cable (Leading Edge Units)
<b>Main Shaft</b>	Stainless Steel	<b>Tie Back Extension</b>	Polyester
<b>SW-9012 Bracket</b>	Forged Steel	<b>Snap Hook / Rebar Hook</b>	Forged Steel or Aluminum
<b>Dual Bracket BWB</b>	Alloy Steel, Heat Treated w/ Plastic Keeper	<b>9013 Bracket</b>	Forged Steel Gate, Aluminum Barrel

## 7.1 PRODUCT SPECIFICATIONS

**TABLE 11 - PRODUCT SPECIFICATIONS**

Item	Length	Class
FS-FSP1211-G	11	A
FS-FSP1211-G-RBH	11	A
FS-FSP1215-G	15	A
FS-FSP1220-G	20	A
FS-FSP9020 (LEADING EDGE)	20	B
FS-FSP9030 (LEADING EDGE)	30	B
FS-FSP1230-G	30	B
FS-FSP1250-G	50	B
FS-FSP9050 (LEADING EDGE)	50	B
FS-FSP1265-G	65	B
FS-FSP1275-G	75	B
FS-FSP1407-W	7	A
FS-FSP1407-W-RBH	7	A
FS-FSP1407-W-TBH	7	A
FS-FSP14075-W	7	A
FS-FSP14085-W-RBH	7	A
FS-FSP14075-W-TBH	7	A
FS-FSP15075-W-BWB	7	A
FS-FSP15085-W-RBH-BWB	7	A
FS-FSP1409-W	9	A
FS-FSP1409-W-RBH	9	A
FS-FSP1409-W-DL	9	A
FS-FSP1409-W-DL-RBH	9	A
FS-FSP1409-W-DL-BWB	9	A
FS-FSP1409-W-DL-RBH-BWB	9	A
FS-FSP1411-W	11	A
FS-FSP1411-W-RBH	11	A
FS-FSP14095-W	11	A
FS-FSP14095-W-RBH	11	A

Item	Length	Class
FS-EX1006-W	6	A
FS-EX1006-W-RBH	6	A
FS-EX10065-W-BWB	6	A
FS-EX10065-W-RBH-BWB	6	A
FS-EX20065-W-RBH-BWB	6	A
FS-EX1420-W	20	B
FS-EX2530-G-SL	30	B
FS-EX1530-W	30	B
FS-EX1540-W	40	B
FS-EX1550-W	50	B
FS960-65	65	B
FS-EX2550-G-SL	50	B
FS-EX1080-G	80	B
FS-EX10-100-G	100	B

Item	Length	Class
SW-8008-10	10	A
SW-8008-10-ALU	10	A
SW-8008-10-RBH	10	A
SW-8008-10-ALU-RBH	10	A
SW-8008-10-DL	10	A
SW-8008-10-ALU-DL	10	A
SW-8008-10-RBH-DL	10	A
SW-8008-10-ALU-RBH-DL	10	A
SW-8008-11LE (LEADING EDGE)	11	B
SW-8008-11LE-ALU (LEADING EDGE)	11	B
SW-8008-11LE-RBH (LEADING EDGE)	11	B
SW-8008-11LE-RBH-ALU (LEADING EDGE)	11	B
SW-8008-11LE-DL (LEADING EDGE)	11	B
SW-8008-11LE-ALU-DL (LEADING EDGE)	11	B
SW-8008-11LE-RBH-DL (LEADING EDGE)	11	B
SW-8008-11LE-RBH-ALU-DL (LEADING EDGE)	11	B

## 8.0 INSPECTION

### 8.1 BEFORE EACH USE

Before each use ensure that the equipment is in good working condition. Inspect the unit to ensure it has not been damaged and that the unit pays out and retracts properly. Prior to each use, the braking system must be inspected. Grasp the body of the unit in one hand and the cable/web in the other. With a quick, jerking motion, pull down on the web/cable. The brake should engage, stopping movement almost immediately. Inspect the webbing and/or cable (using "Inspection Checklist" p 19) and ensure that all connection hardware is working properly. Brake failure or unsatisfactory results during any portion of the inspection, require immediate removal of the SRD from service.

### 8.2 INSPECTION FREQUENCY

The SAFEWAZE™ SRD - must be inspected at the intervals defined in section 2.3. Inspection procedures are described in the "Inspection Checklist" (See page 19).

### 8.3 UNSAFE OR DEFECTIVE CONDITIONS

Figure 19 shows examples of equipment damage. Equipment inspectors must be trained to look for damage as illustrated in Figure 19, as well as other damage that may occur. If inspection reveals an unsafe or defective condition remove the SRD from service.

### 8.4 PRODUCT LIFE

The working life of SAFEWAZE™ SRD's is determined by work conditions, care and inspection provided. As long as the SRD passes inspection, it may remain in service.

### 8.5 DISPOSAL

Dispose of the SAFEWAZE™ SRD if it has been damaged by fall arrest forces or inspection reveals an unsafe or defective condition that cannot be repaired by an authorized SAFEWAZE™ Service Center. Before disposing of the SRD, cut the cable/web lifeline in half so that it is not mistakenly reused.



FIGURE 16 HOUSING LABELS

**SAFEWAZE™**  
Fall Arrest Systems • Confined Space • Engineering • Rescue Systems  
322 Industrial Court, Concord, NC 28025  
P: (704) 262-7893 or F: (704) 262-9051

**SELF RETRACTING LANYARD**

ANSI Z359.14 & ANSI A10.32  
OSHA 1910.66 & OSHA 1926.502  
WWW.SAFEWAZE.COM™

**FS-FSP1220-G**  
Single Leg / Swivel Indicating Snap Hook

**MUST FOLLOW ALL MANUFACTURER'S INSTRUCTIONS INCLUDED WITH THIS EQUIPMENT. DO NOT REMOVE LABEL.**

**WARNING:** User must read and understand all instructions provided with this product at time of shipment, prior to use. **DO NOT ATTEMPT TO SERVICE OR REPAIR THIS UNIT CONTACT SAFEWAZE™ FOR SERVICE OR REPAIR INFORMATION.**

**USE:** This is a single person fall arrest device. Connection of this device to a full body harness is to be made to the dorsal D-ring only. User must ensure that any connection to anchorage is properly secured prior to use. Avoid direct contact with sharp or abrasive edges. Avoid electrical, thermal and/or electrical hazards. This product is suitable for use with horizontal lifelines and horizontal positioning. Fall clearance must be calculated by a Competent Person prior to use. Avoid swing fall hazards. Fall clearance number for this device is based upon unit installed in overhead vertical position in line with the user.

**INSPECTION:** Device must be inspected prior to each use. Inspect device per instructions to include Locking Function Test (sheep pull test), retraction test, label legibility, any evidence of damage or defects, or missing components or parts. Inspect housing, connectors, fasteners and full length of lifeline component for any damage or defects. This product must be inspected by a Competent Person at least every 6 months, or more frequently in harsh environments. Unit must be removed from service if evidence of fall arrest forces. Fall indicator is worn and legibility above the snap hook, immediately remove unit from service if any evidence is displayed.

**Specifications:**  
Working Length: 20 ft (6.10 m)  
Material: 3" in galvanized steel cable, steel hardware, nylon and glass fiber housing  
Capacity range: 150-310 lbs (68.03 kg to 140.61 kg)  
Average arresting force: 1300 lbs (592.33 kg)  
Max arrest force: 1800 lbs (816.47 kg)  
Max arresting distance: 24 in (609.60 mm)  
Free fall limit: 24 in (609.60 mm)

Class A Unit

Year	1	2	3	4	5
2017					
2018					
2019					
2020					
2021					

**SAFEWAZE™**  
Fall Arrest Systems • Confined Space • Engineering • Rescue Systems  
322 Industrial Court, Concord, NC 28025  
P: (704) 262-7893 or F: (704) 262-9051

**SELF RETRACTING LANYARD**

ANSI Z359.14 & ANSI A10.32  
OSHA 1910.66 & OSHA 1926.502  
WWW.SAFEWAZE.COM™

**SAFEWAZE™**  
Fall Arrest Systems • Confined Space • Engineering • Rescue Systems  
322 Industrial Court, Concord, NC 28025  
P: (704) 262-7893 or F: (704) 262-9051

**SELF RETRACTING LANYARD**

ANSI Z359.14 & ANSI A10.32  
OSHA 1910.66 & OSHA 1926.502  
WWW.SAFEWAZE.COM™

**FS-FSP1409-W-RBH**  
Single Leg / Rebar Hook

**MUST FOLLOW ALL MANUFACTURER'S INSTRUCTIONS INCLUDED WITH THIS EQUIPMENT. DO NOT REMOVE LABEL.**

**WARNING:** User must read and understand all instructions provided with this product at time of shipment, prior to use. **DO NOT ATTEMPT TO SERVICE OR REPAIR THIS UNIT CONTACT SAFEWAZE™ FOR SERVICE OR REPAIR INFORMATION.**

**USE:** This is a single person fall arrest device. Connection of this device to a full body harness is to be made to the dorsal D-ring only. User must ensure that any connection to anchorage is properly secured prior to use. Avoid direct contact with sharp or abrasive edges. Avoid electrical, thermal and/or electrical hazards. This product is suitable for use with horizontal lifelines and horizontal positioning. Fall clearance must be calculated by a Competent Person prior to use. Avoid swing fall hazards. Fall clearance number for this device is based upon unit installed in overhead vertical position in line with the user.

**INSPECTION:** Device must be inspected prior to each use. Inspect device per instructions to include Locking Function Test (sheep pull test), retraction test, label legibility, any evidence of damage or defects, or missing components or parts. Inspect housing, connectors, fasteners and full length of lifeline component for any damage or defects. This product must be inspected by a Competent Person at least every 6 months, or more frequently in harsh environments. Unit must be removed from service if evidence of fall arrest forces. Fall indicator is worn and legibility above the snap hook, immediately remove unit from service if any evidence is displayed.

**Specifications:**  
Working Length: 18 ft (5.49 m)  
Material: Steel hardware, nylon and glass fiber housing  
Capacity range: 150-310 lbs (68.03 kg to 140.61 kg)  
Average arresting force: 1300 lbs (592.33 kg)  
Max arrest force: 1800 lbs (816.47 kg)  
Max arresting distance: 24 in (609.60 mm)  
Free fall limit: 24 in (609.60 mm)

Class A Unit

Year	1	2	3	4	5
2017					
2018					
2019					
2020					
2021					

**FS-EX1006-W-RBH**  
Single Leg / Rebar Hook

**MUST FOLLOW ALL MANUFACTURER'S INSTRUCTIONS INCLUDED WITH THIS EQUIPMENT. DO NOT REMOVE LABEL.**

**WARNING:** User must read and understand all instructions provided with this product at time of shipment, prior to use. **DO NOT ATTEMPT TO SERVICE OR REPAIR THIS UNIT CONTACT SAFEWAZE™ FOR SERVICE OR REPAIR INFORMATION.**

**USE:** This is a single person fall arrest device. Connection of this device to a full body harness is to be made to the dorsal D-ring only. User must ensure that any connection to anchorage is properly secured prior to use. Avoid direct contact with sharp or abrasive edges. Avoid electrical, thermal and/or electrical hazards. This product is suitable for use with horizontal lifelines and horizontal positioning. Fall clearance must be calculated by a Competent Person prior to use. Avoid swing fall hazards. Fall clearance number for this device is based upon unit installed in overhead vertical position in line with the user.

**INSPECTION:** Device must be inspected prior to each use. Inspect device per instructions to include Locking Function Test (sheep pull test), retraction test, label legibility, any evidence of damage or defects, or missing components or parts. Inspect housing, connectors, fasteners and full length of lifeline component for any damage or defects. This product must be inspected by a Competent Person at least every 6 months, or more frequently in harsh environments. Unit must be removed from service if evidence of fall arrest forces. Fall indicator is worn and legibility above the snap hook, immediately remove unit from service if any evidence is displayed.

**Specifications:**  
Working Length: 18 ft (5.49 m)  
Material: Aluminum hardware, Thermoplastic housing, high strength Polyester housing  
Capacity range: 150-310 lbs (68.03 kg to 140.61 kg)  
Average arresting force: 1300 lbs (592.33 kg)  
Max arrest force: 1800 lbs (816.47 kg)  
Max arresting distance: 24 in (609.60 mm)  
Free fall limit: 24 in (609.60 mm)

Class B Unit

Year	1	2	3	4	5
2017					
2018					
2019					
2020					
2021					

**SAFEWAZE™**  
Fall Arrest Systems • Confined Space • Engineering • Rescue Systems  
322 Industrial Court, Concord, NC 28025  
P: (704) 262-7893 or F: (704) 262-9051

**SELF RETRACTING LANYARD**

**LE LEADING EDGE**

ANSI Z359.14 & ANSI A10.32  
OSHA 1910.66 & OSHA 1926.502  
WWW.SAFEWAZE.COM™

**FS-FSP9030**  
30 FT LEADING EDGE CABLE

**MUST FOLLOW ALL MANUFACTURER'S INSTRUCTIONS INCLUDED WITH THIS EQUIPMENT. DO NOT REMOVE LABEL.**

**WARNING:** User must read and understand all instructions provided with this product at time of shipment, prior to use. **DO NOT ATTEMPT TO SERVICE OR REPAIR THIS UNIT CONTACT SAFEWAZE™ FOR SERVICE OR REPAIR INFORMATION.**

**USE:** This is a single person fall arrest device. Connection of this device to a full body harness is to be made to the dorsal D-ring only. User must ensure that any connection to anchorage is properly secured prior to use. Avoid electrical, thermal and/or electrical hazards. This product is suitable for use with horizontal lifelines and horizontal positioning. Fall clearance must be calculated by a Competent Person prior to use. Avoid swing fall hazards. Free fall limit is 24 in.

**INSPECTION:** Device must be inspected prior to each use. Inspect device per instructions to include Locking Function Test (sheep pull test), retraction test, label legibility, any evidence of damage or defects, or missing components or parts. Inspect housing, connectors, fasteners and full length of lifeline component for any damage or defects. This product must be inspected by a Competent Person at least every 6 months, or more frequently in harsh environments. Unit must be removed from service if evidence of fall arrest forces. Fall indicator is worn and legibility above the snap hook, immediately remove unit from service if any evidence is displayed.

**Specifications:**  
Material: 7/32 in galvanized steel cable, steel hardware, nylon and glass fiber housing  
Capacity range: 150-310 lbs (68.03 kg to 140.61 kg)  
Average arresting force: 1300 lbs (592.33 kg)  
Max Arresting Distance: 24 in (609.60 mm)  
Sublock distance: 3 ft  
Minimum Fall Clearance: 12.5 ft (3.81 m)

Class B Unit

Year	1	2	3	4	5
2017					
2018					
2019					
2020					
2021					

**SAFEWAZE SAFELINK™**  
322 Industrial Court, Concord, NC 28025  
P: (704) 262-7893 or F: (704) 262-9051

**SELF RETRACTING LANYARD**

ANSI Z359.14 & ANSI A10.32  
OSHA 1910.66 & OSHA 1926.502  
WWW.SAFEWAZE.COM™

**SAFEWAZE™**  
**FS-EX2530-G-SL**  
Single Leg / Double Locking Snap Hook

**MUST FOLLOW ALL MANUFACTURER'S INSTRUCTIONS INCLUDED WITH THIS EQUIPMENT. DO NOT REMOVE LABEL.**

**WARNING:** User must read and understand all instructions provided with this product at time of shipment, prior to use. **DO NOT ATTEMPT TO SERVICE OR REPAIR THIS UNIT CONTACT SAFEWAZE™ FOR SERVICE OR REPAIR INFORMATION.**

**USE:** This is a single person fall arrest device. Connection of this device to a full body harness is to be made to the dorsal D-ring only. User must ensure that any connection to anchorage is properly secured prior to use. Avoid electrical, thermal and/or electrical hazards. This product is suitable for use with horizontal lifelines and horizontal positioning. Fall clearance must be calculated by a Competent Person prior to use. Avoid swing fall hazards. Free fall limit is 24 in.

**INSPECTION:** Device must be inspected prior to each use. Inspect device per instructions to include Locking Function Test (sheep pull test), retraction test, label legibility, any evidence of damage or defects, or missing components or parts. Inspect housing, connectors, fasteners and full length of lifeline component for any damage or defects. This product must be inspected by a Competent Person at least every 6 months, or more frequently in harsh environments. Unit must be removed from service if evidence of fall arrest forces. Fall indicator is worn and legibility above the snap hook, immediately remove unit from service if any evidence is displayed.

**Specifications:**  
Working Length: 30 ft (9.14 m)  
Material: 3/16 in (4.76mm) galvanized steel cable, steel hardware, high strength Polyester housing  
Capacity: 330-310 lbs (149.69 kg to 140.61 kg)  
Average arrest force: 1300 lbs (592.33 kg)  
Max Arresting Distance: 54 in (1371.6 mm)  
Minimum Fall Clearance: 12.5 ft (3.81 m)

Class B Unit

Year	1	2	3	4	5
2017					
2018					
2019					
2020					
2021					

FIGURE 17 - SERIAL NUMBER & DATE OF MANUFACTURE





## 9.1 LABELING PICTOGRAM IMAGES AND DEFINITIONS (MAY BE PRESENT ON EARLIER VERSIONS)

PICTURE 1.1



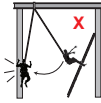
Store the fall arrester, hanging up, in a ventilated place away from humidity and from ultraviolet light.

PICTURE 1.2



Per ANSI/OSHA regulations, anchorage points must support a minimum of 5,000 lbs. Per EU EN 795 standard, anchorages must have a resistance superior to 10 kN.

PICTURE 1.3



Avoid swing fall hazards. Work as directly underneath your anchorage as possible. Always check for obstructions below your work area to ensure your fall path is clear.

PICTURE 1.4



Ensure cable or webbing does not show any sign of wear (i.e., tearing, fraying, breaking, corrosion, etc.).

PICTURE 1.5



Do not allow the lanyard to retract into the housing freely. This may damage the retracting mechanism.

PICTURE 1.6



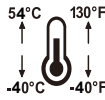
Use of this equipment should be avoided in areas where the lifeline may come into contact with sharp, abrasive and/or leading edges, unless designated LE certified.

PICTURE 1.7



Retractable lifeline should only be attached to back dorsal D-ring of fall protection full-body harness.

PICTURE 1.8



Temperature of use: from -30°C to +50°C or -22°F to 122°F.

PICTURE 1.9



Maximum weight capacity listed, 310 lbs (140 kg), is for a single user, including all clothing, equipment and tools.

PICTURE 1.10



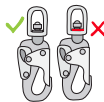
It is strictly forbidden to modify or repair this device yourself. Only the manufacturer or a qualified repair center is authorized to carry out these repairs.

PICTURE 1.11



The braking function operates by giving a quick downward tug on the cable or web lifeline. When testing the braking function, pull straight down on the lifeline element, not to the side of the retractable housing.

PICTURE 1.12



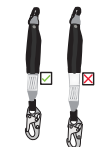
Do not use and remove from service if load indicator is deployed (on cable units).

PICTURE 1.13



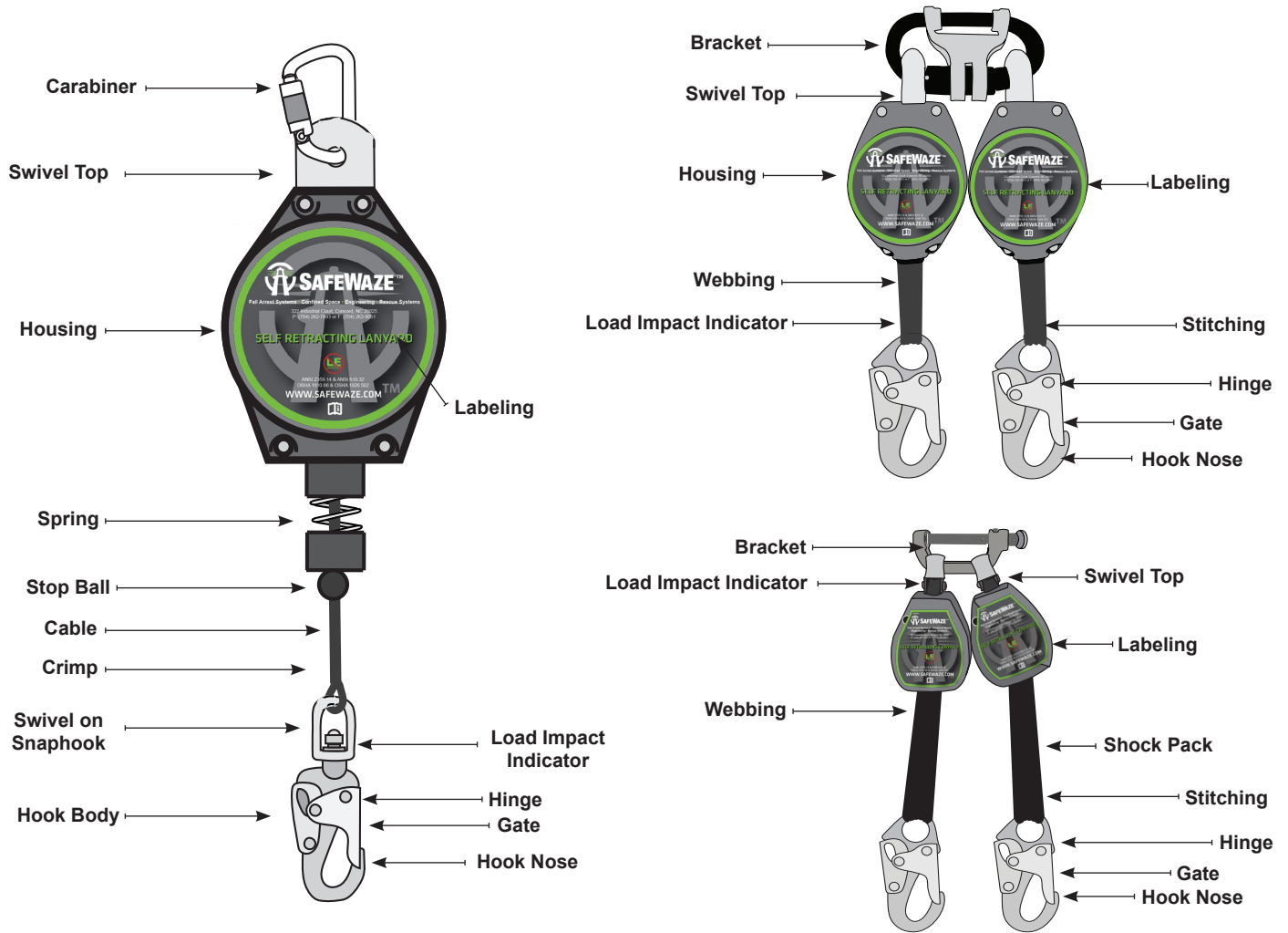
Do not use and remove from service if sewn in load indicator is deployed (on web units).

PICTURE 1.14



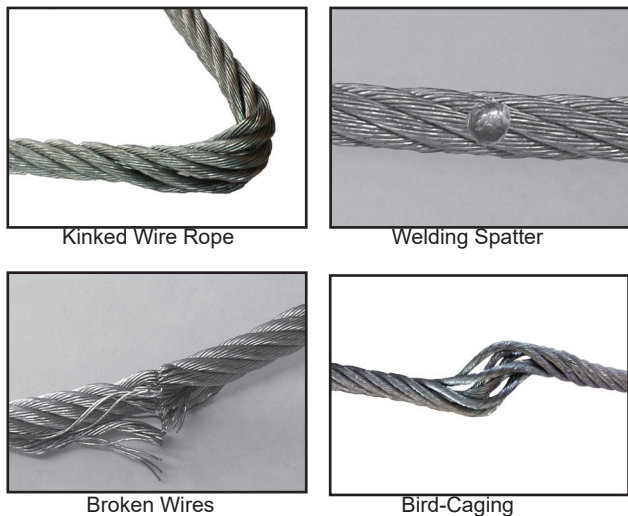
Do not use if shock pack incorporated on certain cable units (Including LE Units) indicates signs of deployment due to fall arrest forces.

**FIGURE 18 - INSPECTION DIAGRAMS**

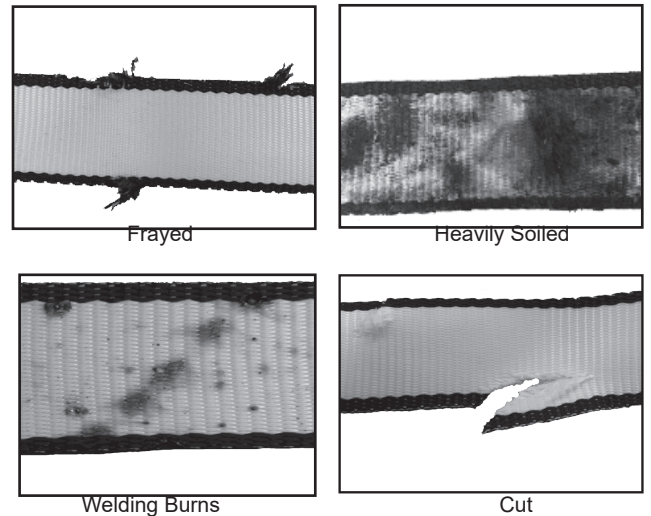


**FIGURE 19 - EXAMPLES OF EQUIPMENT DAMAGE**

**Cable Damage Examples**



**Webbing Damage Examples**



# Inspection Checklist - Fall Protection Equipment

## Retractable Lifeline

<b>Description:</b>		<b>Model #:</b>	
<b>Serial #:</b>		<b>Date of Manufacture:</b>	
<b>Inspector:</b>		<b>Date Inspected:</b>	
	Description	Pass <input checked="" type="checkbox"/>	Fail <input checked="" type="checkbox"/>
<b>Main Unit</b>	Webbing or Cable		
	Stitching or Crimp		
	Stop Ball (cable only)		
	Spring (cable only)		
	Housing		
	Labeling or Engraving		
	Swivel Top		
<b>Hooks &amp; Carabiners</b>	Swivel on Sanphook (cable only)		
	Hook Body		
	Hook Nose		
	Load Impact Indicator		
	Gate (keeper)		
	Hinge (at gate)		
	Bracket (dual only)		
	Carabiner		
<b>Tests</b>	Retraction & Tension		
	Braking Test		
<b>✓ PASS: Initial _____</b>		<b>x FAIL: Initial _____</b>	
<b>Inspector Signature: _____</b>			

SERIAL NUMBER:			
MODEL NUMBER:			
DATE OF PURCHASE:			
INSPECTION DATE	NOTES	CORRECTIVE ACTION	MAINTENANCE PERFORMED
APPROVED BY:			
APPROVED BY:			
APPROVED BY:			
APPROVED BY:			
APPROVED BY:			
APPROVED BY:			
APPROVED BY:			
APPROVED BY:			
APPROVED BY:			
APPROVED BY:			

**TABLE 12 - 420 LB CAPACITY UNITS**

<b>420 lb Capacity Self Retracting Devices</b>
SW-8008-10
SW-8008-10-ALU
SW-8008-10-RBH
SW-8008-10-ALU-RBH
SW-8008-10-DL
SW-8008-10-ALU-DL
SW-8008-10-RBH-DL
SW-8008-10-ALU-RBH-DL

**TABLE 13 - 400 LB CAPACITY UNITS**

<b>400 lb Capacity Self Retracting Devices</b>
FS-EX1006-W
FS-EX1006-W-RBH
FS-EX10065-W-BWB
FS-EX10065-W-RBH-BWB
FS-EX2006-W-RBH
FS-EX20065-W-RBH-BWB



**SAFEWAZE™**  
322 Industrial Court  
Concord, NC 28025

**PHONE: 1-704-262-7893**  
**FAX: 1-704-262-9051**

**WEB: [safewaze.com](http://safewaze.com)**  
**EMAIL: [info@safewaze.com](mailto:info@safewaze.com)**